

ALGORITHM FOR CORRECTION OF PRIMARY SPECTROMETRIC DATA

Nedyalko Todorov Katrandzhiev

Department of Computer Systems and Technologies, University of Food Technologies,
26 Maritza Blvd., Plovdiv 4000, Bulgaria, phone: +359 88 7 611 893,
e-mail: sundy76@yahoo.com, url: www.geocities.com/sundy76

In practice the collecting of the educational data for a opto-electronic system is a long process. When it is about collecting data for seasonal production, the process itself becomes seasonal. But if the system which scans the production doesn't function properly, we have two alternatives – to stop the measurement and to correct the system, thus we are missing the season and we are waiting for the next one or we can analyze the problem and decide whether the data could be processed later without any loss of information. This publication examines the exact same problem in Lock-In amplifier of the NIR system.

Keywords: pick, correction, log-in amplifier, spectrometric data

1. PROBLEM STATEMENT

While scanning, there were spectral characteristics that featured peak measurements. These were distributed at random along the length of the spectrum.

Because it was not clear what exactly the problem was, and the produce to be measured (apples) was awaiting that to happen, we decided to continue with the measurement and clean up the graphs of unwanted, random peak values by finding a software solution to the problem at a later stage. For this purpose was created an algorithm that checks all available data for peak values, eliminates them and delivers newly corrected data.

1.1 Introduction of Log-in amplifier

All lock-in amplifiers, whether analogue or digital, rely on the concept of phase sensitive detection for their operation.

Stated simply, phase sensitive detection refers to the demodulation or rectification of an ac signal by a circuit which is controlled by a reference waveform derived from the device which caused the signal to be modulated. The phase sensitive detector effectively responds to signals which are coherent (same frequency and phase) with the reference waveform and rejects all others.

In a light measurement system the device which causes the signal to be modulated is usually a chopper, the reference waveform is an output coherent with the chopping action provided by the chopper and the ac signal is the signal from the photodetector.

Consider a simple light measurement system being used to measure transmission. Light from a stable light source is passed through a sample and reaches a detector. The resulting electrical signal from the detector is amplified and displayed on a meter. The meter reading gives an indication of the amount of light transmitted by the

sample (Fig. 1). With medium to high transmission samples this system would be expected to give precise and reproducible results.

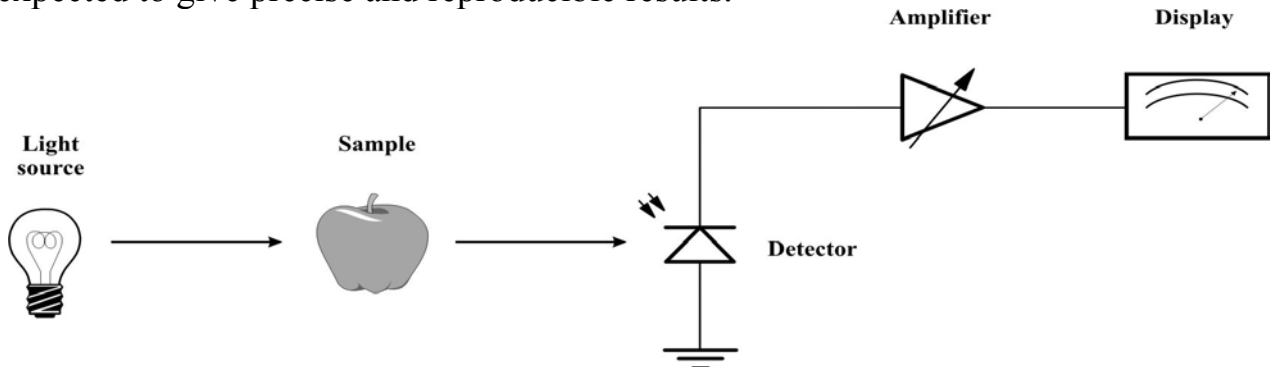
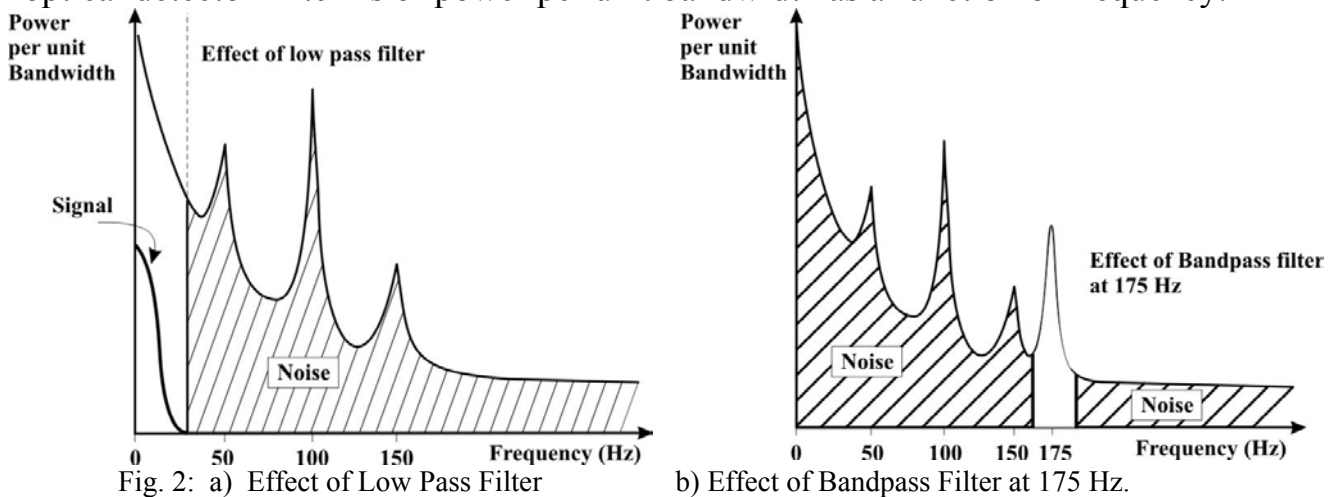

Fig. 1 - Schematic of Lock-in Device

Samples of increasing optical density could be accommodated by increasing the gain of the amplifier. What is always noticeable in such systems, however, is that as the signal level falls and the amplifier gain is increased so the precision with which the results can be recorded also falls. This is due to noise. The noise in this sense is anything which contributes to the meter reading.

The following diagram shows the distribution of noise and signal power from the optical detector in terms of power per unit bandwidth as a function of frequency.



This can be used for a situation where the density of the sample is so high that the signal is smaller than the noise with the result is that the instrument becomes unusable (Fig. 2a). What we really need to do if we want to measure high optical density with this system is to move the signal information away from the high noise zero hertz region (Fig. 2b).

We can do this by placing an optical chopper, which will periodically (175Hz) interrupt the light, between the light source and the detector. We have moved the signal away from a region where the background noise is high to a region where it is low. We can now pass the signal through an electronic bandpass filter which will reject both the noise at higher and lower frequencies (including zero hertz) and hence significantly improve the signal to noise ratio.

The problem now is that the signal is ac, i.e. its average value is zero so to record a value from it we must first rectify it. We might end up with an arrangement as

shown in Fig. 3 which includes an amplifier, a tuned filter whose centre frequency is at 175Hz, a rectifying circuit and a display.

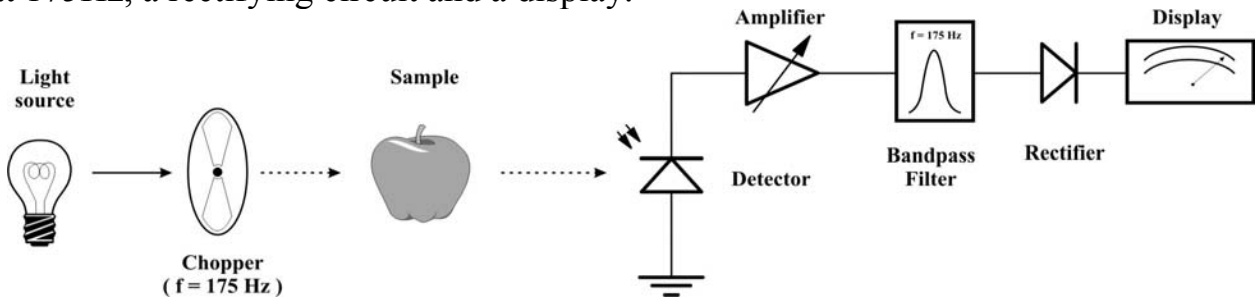

Fig. 3 - Log-In amplifier with a Chopper

Tuned amplifiers, as these devices are called, are used in some simple systems but they suffer from 3 major disadvantages.

Q is defined as the bandwidth of a filter divided by its centre frequency.

In this application the narrower the bandwidth of the filter, the greater is the noise rejection. The maximum Q typically achievable for a tuned amplifier is in the region of 100, but in a demanding measurement situation we might need a Q of 1000 to achieve acceptable signal to noise ratio.

Secondly, if such a filter could be produced any small shift in chopping frequency would result in large changes in output due to misalignment between signal frequency and filter centre frequency.

The third problem lies in the rectifying device and the way it responds to noise which passes through the filter. Using a normal rectifying device such as a semiconductor diode the noise itself will be rectified and will thus give rise to a dc level at the meter which will be indistinguishable from that derived from the signal.

All these problems are overcome by the phase sensitive detector (Fig. 4).

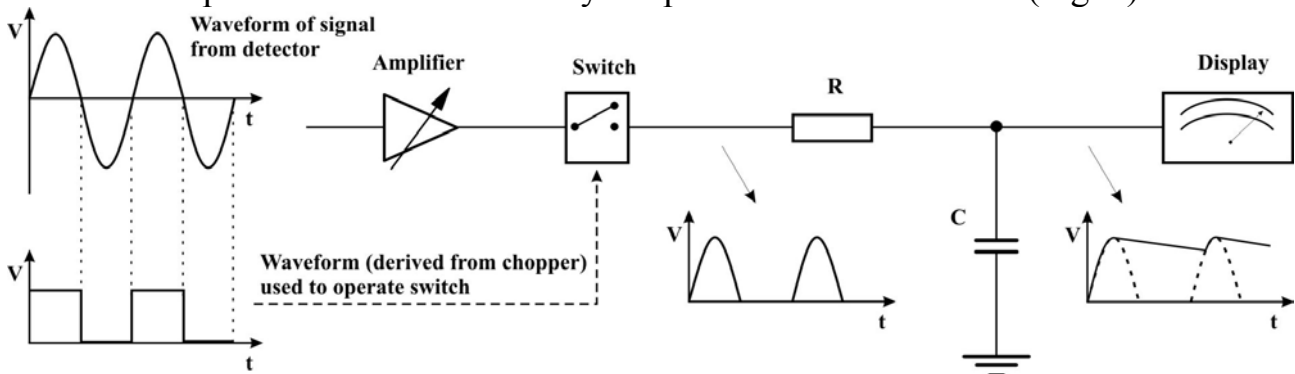

Fig. 4 - Synchronous Filter

As before there is circuitry to amplify low level signals, but now there is no tuned filter or rectifying diode. Instead the amplifier is followed by a switch which is operated by a waveform derived from the chopper. When the level from the chopper is high the switch is closed and the output of the amplifier is connected directly to a low pass filter consisting of a resistor (R) and a capacitor (C). When the output of the chopper is low the switch is open and no connection is made.

Rectification of the signal occurs when the waveform controlling the switch is exactly in phase with the ac signal at the input to the switch. More importantly when the switch is closed the noise associated with the signal passes through un-rectified to

the low pass RC filter beyond where it is smoothed or averaged to its mean value of zero.

1.2 Algorithm for correction

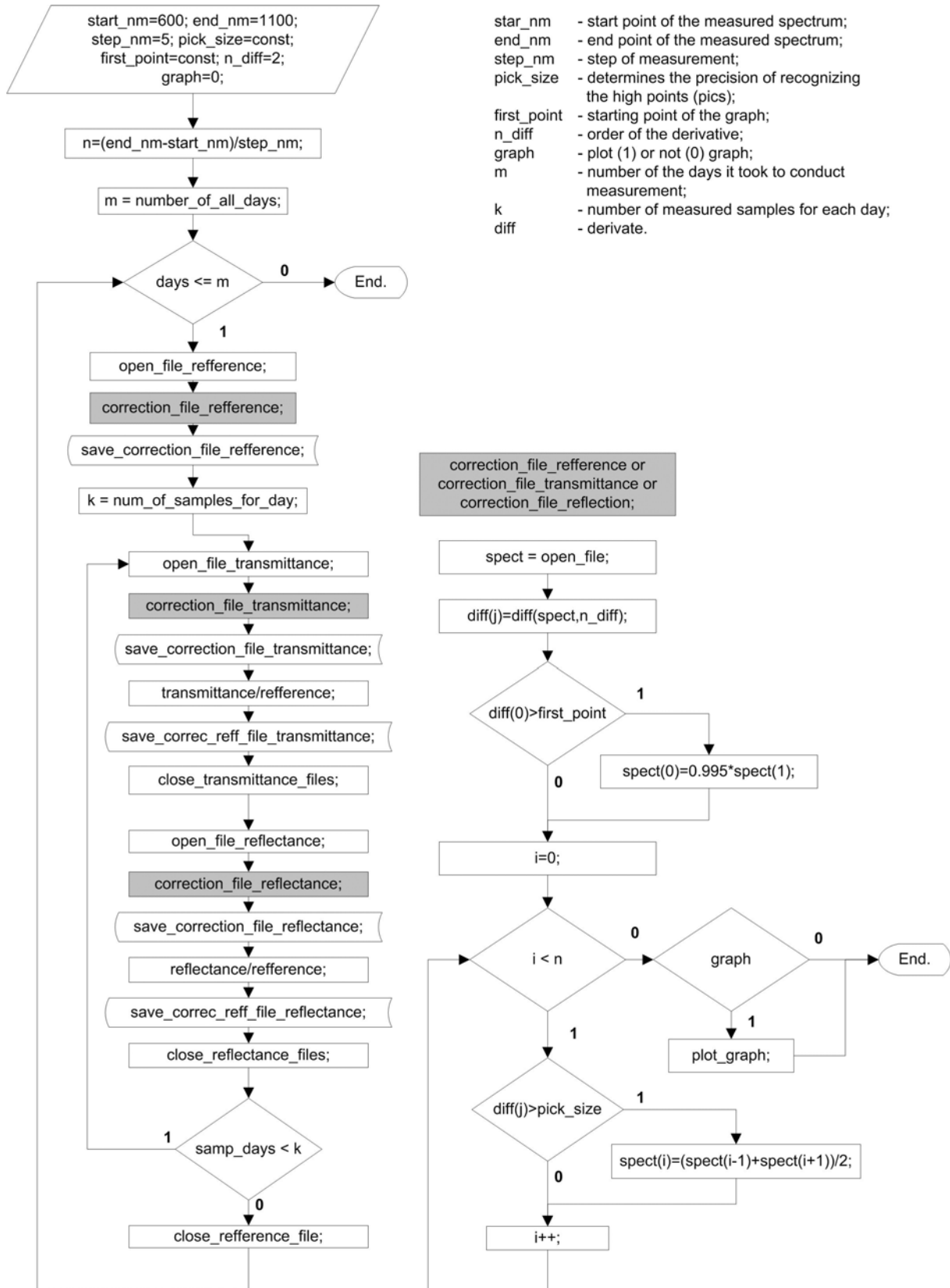

- star_nm - start point of the measured spectrum;
- end_nm - end point of the measured spectrum;
- step_nm - step of measurement;
- pick_size - determines the precision of recognizing the high points (pics);
- first_point - starting point of the graph;
- n_diff - order of the derivative;
- graph - plot (1) or not (0) graph;
- m - number of the days it took to conduct measurement;
- k - number of measured samples for each day;
- diff - derivate.

Fig. 5 - Algorithm

2. RESULTS

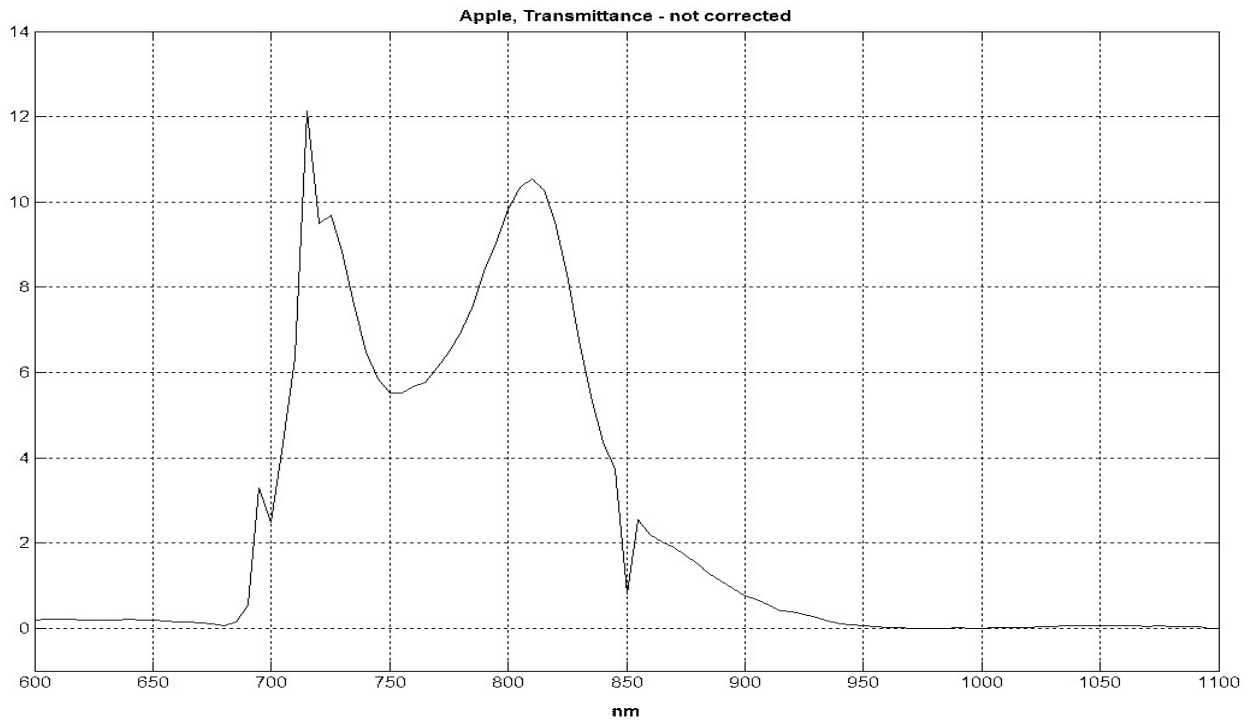

Fig. 6 - Not corrected spectrum

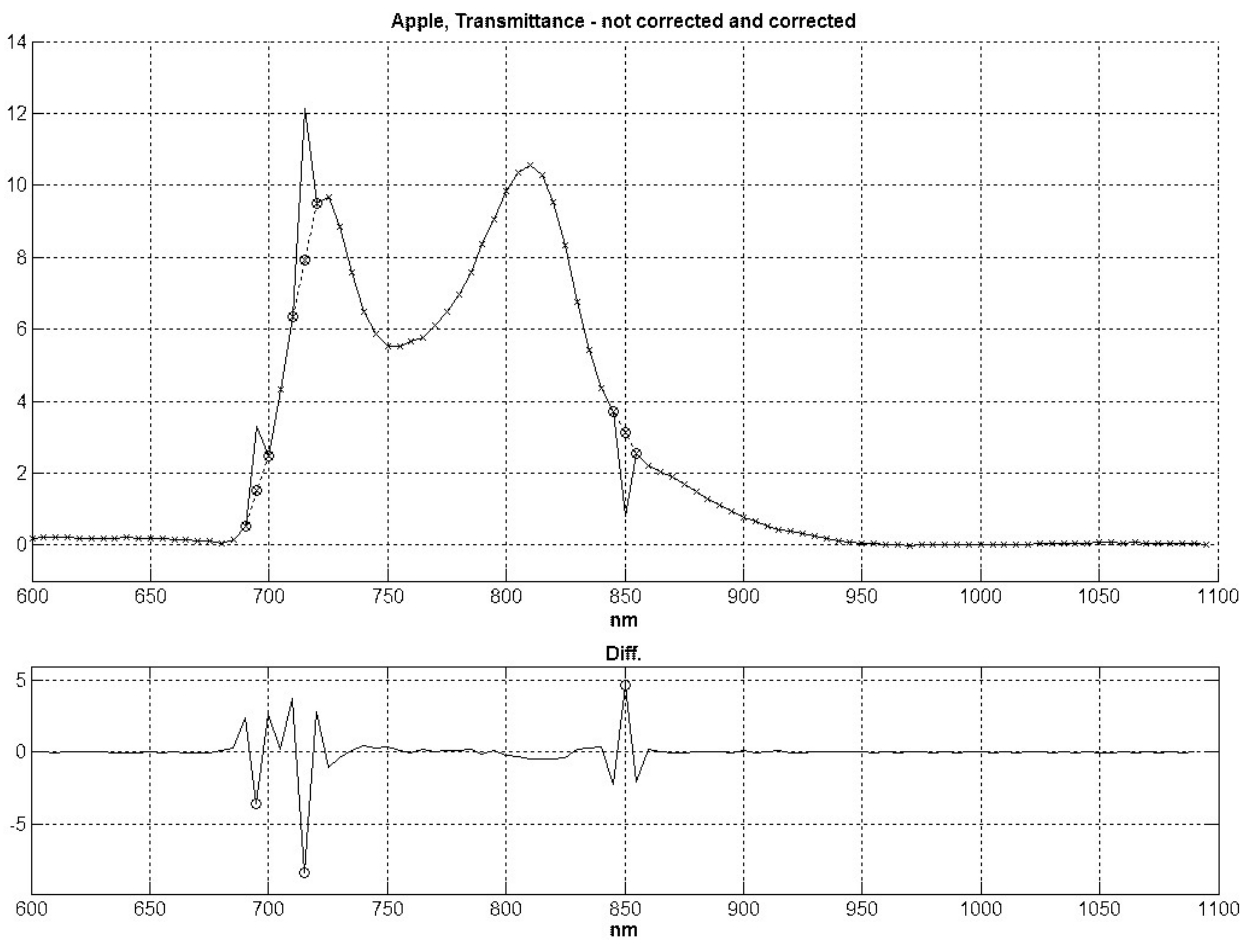

Fig. 7 - Correction of the transmittance spectrum of an apple through its 2nd derivate

Figure 6 is showing the graphics that are not corrected yet. Identification of the peak values is done by figuring out the second derivate (Fig. 7). As the peak values come out within the framework of one point, their obliteration is easily done by skipping that point and picking up the average value of the points before and after it. The already corrected spectrum is shown on figure 8.

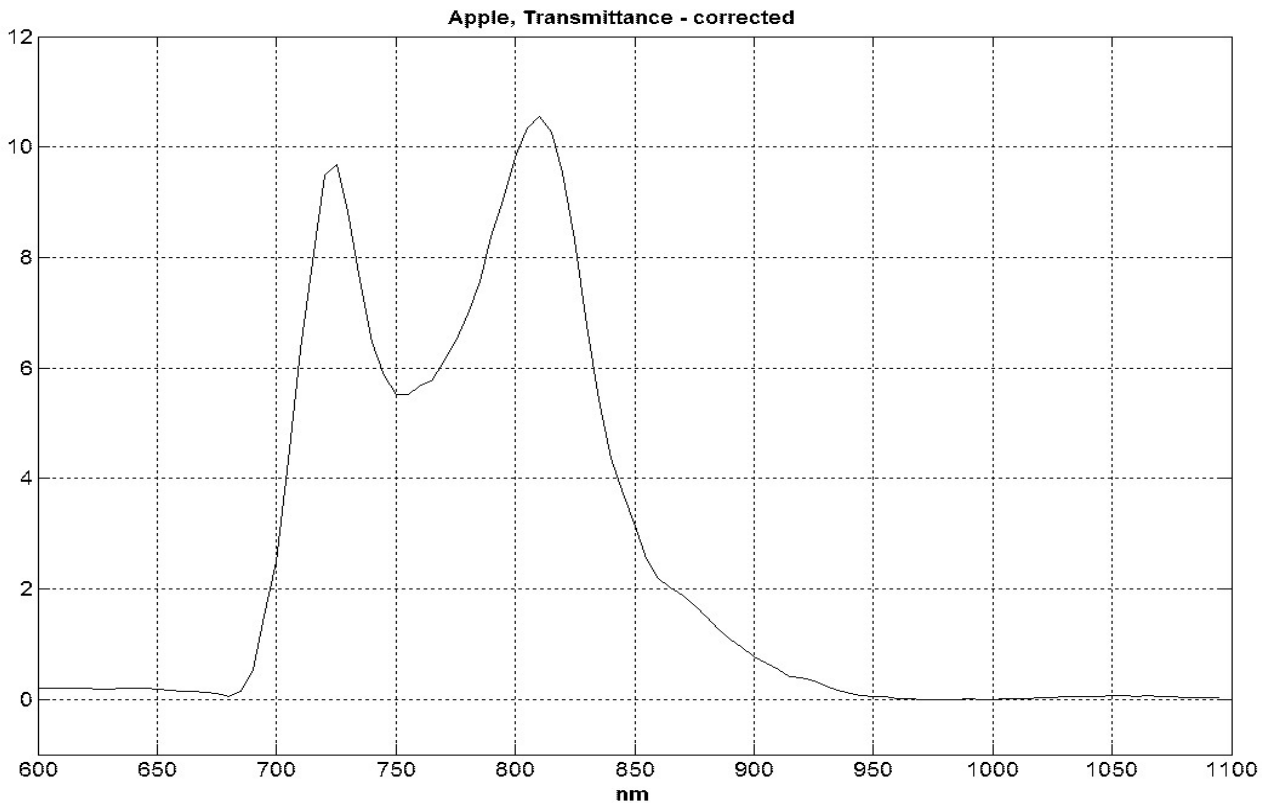

Fig. 8 - Corrected spectrum

3. CONCLUSIONS

With the help of this algorithm the true value of the data was saved and analysed in an accurate way.

After the end of season we found out that these peak values are recorded when the scope of the Lock-in amplifier changes. We managed to eliminate this issue.

4. REFERENCES

- [1] Bentam Instruments, Lock-In Amplifiers.